



CATALOGUE



INDOE ENTERPRISE

MAKE THE THINKS HAPPEN

1.5-25mm manual hand-cranked small wire stripper machine scrap copper cable stripping wire peeling machine

Essential details

- model-IE-025 [?](#)
- Wire thickness range - 0,06-1 inch/1,5-25mm
- Stripping speed - Ca. 50 ft/min
- volume - 7x7.4x14.7 inch/18x19x37.5 cm [?](#)
- Product weight -3.7kg
- Function - peel off wires



High speed home using small electric scrap copper cable stripping machine automatic scrap wire recycling stripper machine



- Essential details
- Colour-Sea blue
- Model-IE-025
- Voltage-110V/220V
- Volume-385*345*385mm
- Compatible wire thickness-1.5mm-25mm
- Function-peel off wires
- Weigh-12.7KG
- 100% COPPER MOTOR
- SUPER SILENT - HIGH POWER - LOW HEAT
- Use of high quality pure copper core motor is not afraid of super thick wire skin, a peel to the end.

Manual Cable and Wire Stripper

MANUEL small cable wire stripper tool 1-20mm scrap copper DIY scrap wire stripping machine

- **Essential details**

- Model Number:-IE-M15
- Usage:-Stripping
- Product Name:-1-20mm Manual wire stripping machine
- Wire Gauge Range:-1mm-20mm
- Dimensions:-38L x 28 Wx 20H cm
- Weigh:-20KG
- Advantage:-DIY & Electric
- Color:-Blue



Small volume all kinds of wire recycling line second-hand cable stripping machine High-speed scrap copper recycling machine

- Stripping range – 1.2- 38 mm
- Blades – 10
- Channels – 11
- Power pack 110v/220v



A: flat cable feeding hole	B: 1.5~6mm diameter feeding hole
C: 6.0~9.0 diameter feeding hole	D: 9.0~13mm diameter feeding hole
E: 13.0~16.0mm diameter feeding hole	F: 16.0~19.0 diameter feeding hole
G: 19.0~24mm diameter feeding hole	H: 24~28 mm diameter feeding hole
I: 28~38 diameter feeding hole	J: Adjust Handle
K: Stop Button	L: Switch

Scrap copper cable wire stripping recycling machine used cable processing machine for wire stripper recycle wire

Essential details

- Model Number: IE-KA
- Usage:-scrap copper stripping machine, Recycling scrap copper wires
- Model:-Scrap Copper Wire Stripping Machine
- Motor:-Pure Copper
- Working Mode:-Double Knives/Peelers
- Motor – 2hp ? Dimension:-540*520*840mm
- Support OD:-0.5-40mm ?
- Voltage Power:-220V/1.5KW 220V/2.2KW 380V/1.5KW
- Daily production quantity:-100-600Kg



Electric CUTMASTER Automatic Scrap Cable Wire Stripping Machine, Capacity: 100kg To 1500kgs



Product Description

Specially designed For Copper Wires and Small Aluminium Wires. This machine Can produce 100Kg to 1500Kgs Per shift. In This machine the wire Range Is From 1MM to 55MM.

Product Specification

- Model Name/Number-IE-KOF
- Capacity - 1200kg to 1500Kgs
- Automatic Grade- Semi-Automatic
- Power Source- Electric
- Voltage - 220 V/440V
- Frequency - 50 Hz
- Phase- Single Phase/ Motor – 3hp
- Maximum Wire Diameter- 55MM
- Blade: 26
- Hole: 13

Automatic Scrap Copper Wire Stripping Machine

Product Description

Specially designed For Copper Wires and Small Aluminum Wires. This machine Can produce 100Kg to 1500Kgs Per shift. In This machine the wire Range Is From 1MM to 45MM

Product Specification

- Model Name/Number-IE-KOB
- Capacity - 800kg to 1000Kgs
- Automatic Grade- Semi-Automatic ?
- Power Source- Electric
- Voltage - 220 V/440V
- Frequency - 50 Hz ?
- Phase- Single Phase/ Motor – 3hp
- Maximum Wire Diameter- 45MM
- Blade: 26
- Hole: 18



CABLE WIRES CUT & SEPARATE MACHINE V-C03

TECHNICAL PARAMETERS

Name	COPPER RECYCLING MACHINE
Model	V-C03
Power	5.2kW
Capacity	40~50kg per hour
Can cut cables	0.1~30mm in diameter
Blade quantity	3+2 pieces
Forging Process	D2
Blade life	1~2 years
	The blade can be re-sharpened
Separate rate	99.99% pure copper/aluminum
Machine size	1090*740*1850mm
Net weight	397kg
Noise decibels	50~70 db
Voltage	110V/220V 1phase 220V/380V/400V 3phase
Electrical connection	Plug or Air Switch

- High separation rate, can get 99.99% pure copper
- High efficiency: Capacity 40~50kg per hour mixed cables, 50~60kg per hour square wires, If you have a higher quality cable, the capacity will be higher
- Wide range: All kinds of household cables, communication cables, car cables without plugs, square wires etc, in the diameter range of 0.1 to 30 mm can be shredded and separated
- Low footprint
- High return: you can cover the cost and get high return in 1~2 months



CABLE WIRES CUT & SEPARATE MACHINE V-C06

TECHNICAL PARAMETERS

Name	COPPER MACHINE	RECYCLING
Model	V-C06	
Power	12.19kW	
Capacity	50~80kg per hour	
Can cut cables	0.1~30mm in diameter	
Blade quantity	5+2 pieces	
Forging Process	D2	
Blade life	1~2 years	
	The blade can be re-sharpened	
Separate rate	99.99% copper/aluminum	pure
Machine size	1360*1360*1915mm	
Net weight	1200kg	
Noise decibels	50~70 db	
Voltage	220V/380V/400V 3phase	
	110V/220V 1phase + USD1000	
Electrical connection	Three phase four wire	

- High separation rate, can get 99.99% pure copper
- High efficiency: Capacity 50~80kg per hour mixed cables, 80~100kg per hour square wires, If you have a higher quality cable, the capacity will be higher
- Wide range: All kinds of household cables, communication cables, car cables without plugs, square wires etc. in the diameter range of 0.1 to 30 mm can be shredded and separated
- Low footprint
- High return: you can cover the cost and get high return in 1~2 months



Model NO. – V-CO1

Automatic Cable Granulator Copper Wire Recycling Machine Small Copper Cable Granulator And Separator Machine

- Model VCO1 copper wire granulator
- Metal Processed- Brass / Copper, Aluminium
- Name-Cable Granulator Copper Wire Recycling Machine
- Size- 840*555*1520mm
- Voltage- 110V/220V/380V/Customized 1Phase
- Process capacity is 20 - 30kg/h
- Separation rate- 99.9%
- Input Materials- Household wires, industrial wires, automotive wires, etc.
- Input Size- 0.1~25mm copper wires
- Application -Scrap copper cable wire recycling
- Function -Waste cable crushing and separating



Copper Recycle machine

- **Product name-** Cable Granulator Recycling Machine
- **Model-** V-C02
- **Range-** 0.1-30mm
- **Weight-** 310 kg
- **Measurement-** 150*120*155 CM
- **Power-** 4.2 kw
- **Production Capacity-** 20-40 kg/h
- **Advantage-** 100% High Copper Purity
- **Voltage-** 380V 50Hz 3Phase/Customized
- **Weight(KG)-** 310



pure copper



palstic

Semi- automatic Wire Seal Terminal Crimping Machine



- Description
- Model Number:IE-2.0T
- Usage: Crimping terminating
- Product name:2.0T semi-automatic mute wire terminal wire crimping press machine
- Function: Crimping Terminal
- Weight:55kg Model:IE-2.0T
- Type: Semi-automatic
- Size:240*270*650
- Stroke:30mm(customized 40mm available)

Features & Advantages

- Feature
- 1. Built-in frequency converter, high speed and low noise
- 2. One machine is suitable for various terminals, very easy to change mold.
- 3. Support manual mode and automatic mode, you can adjust the machine easily in manual mode.
- 4. LED display will show how many terminals have been crimped.
- 5. Speed is adjustable, crimping die designed according to your requirement.
- Advantage
- 1. Equipped with original Japanese Mitsubishi, Panasonic, SMC pneumatic components, Mitsubishi servo and step motor;
- 2. Negative Performance rate below 0.01 %;
- 3. Can work for 24 hours;
- 4. Max output 4500pcs/H;
- 5. 10.4 inch colorful LCD, faster and humane operation interface

	size	size	size	size	Size	size
Output	1.0TON	1.5TON	2.0TON	3.0TON	4.0TON	6.0TON
Application	Computer terminals, DC terminal, AC terminal, single grain terminal, joint terminal					
Nominal Pressure	1000KG	1500KG	2000KG	3000KG	4000KG	6000KG
Frequency Power	400W	550W	750W	1100W	2200W	2200W
Motor Power	250W	550W	750W	1100W	1500W	2200W
Stroke	26mm	30mm(customized 40mm available)				
Power Supply	220V/50Hz, 110V/60Hz					
Net. Weight(KG)	25	38	55	59	96	165
Dimension(MM)	200*200*420	220*250*600	240*270*650	240*270*650	310*210*750	380*310*850

Terminals Apply



Wire Terminal Crimping Otp Mold Applicator for Side Feed Terminal Customized Terminal Crimping Applicator Mold

Description

- Power supply-220V 50Hz ☑
- Applicable wire diameter-10-240mmi ☑ Pressure-30T
- Classification New energy wiring harness processing equipment Power-2300w
- Job formation-350mm
- Crimp width-12.5mm
- Crimping ability-30tons
- Whether customization is supported-Can be customized
- Physical dimension-500 x 450mm x 450mm
- Weight-About-100kg

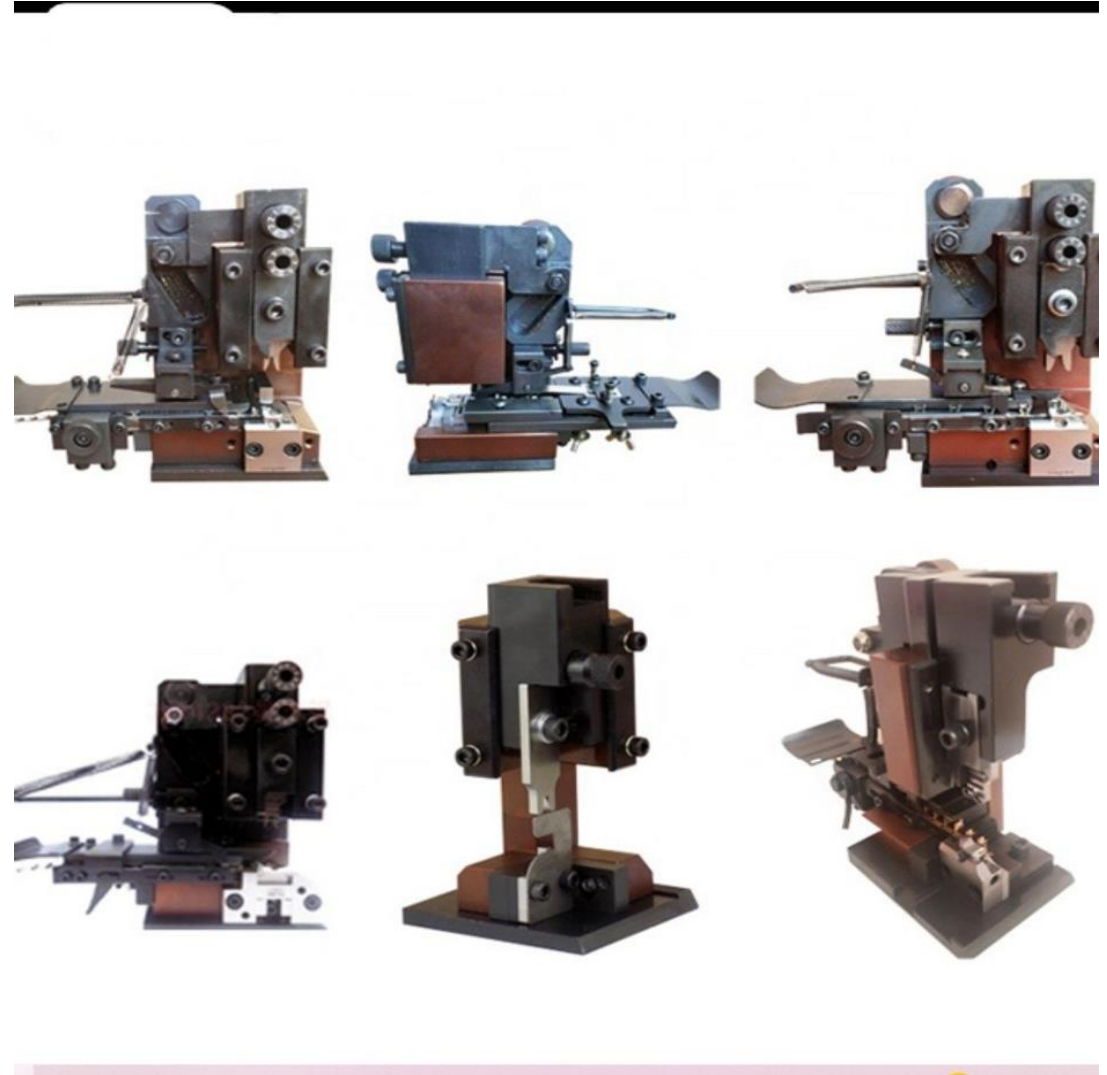

Factory price Bottle Cap Capping Pump Sprayer Semi Automatic Vial Crasp Pressing Pneumatic Crimping Machine For Perfume

- Type:-Capping Machine
- Applicable Industries:-Manufacturing Plant, Machinery Repair Shops, Food & Beverage Factory, Food & Beverage Shops, Perfume and cosmetics factory
- Driven Type:-Pneumatic
- Automatic Grade:-Semi-automatic
- Dimension(L*W*H):-32*28*60cm
- Weight:-20 KG
- Key Selling Points:-High-accuracy
- Product name:-perfume capping machine
- Function:-capping
- Packing Materia:-Aluminium
- Degree of automation-Semi-automatic
- Capping speed:-20-30bottles/min
- Advantage:-easy to operate
- Size of pump cap:-12-22mm
- Air pressure:-0.4-0.6MPa
- Material:-Aluminium Alloy



RJ45 crimper crimping machine for making patch cord cable (Model No. IE-RJ45)

- Product Description
 - RJ45 crimper crimping machine for making patch cord cable
- 1.The cable crimping machine is specially design for producing Internet and phone wire.
 - 2.Various crimping die for your option,
 3. Special pressure British or American telephone plugs.
 4. Die replacing simple
 5. Operation of rare error, high accuracy. Phone PC Head Machine 4P, 6P, 8P and the UK head can be applied

can press normal PC terminal, English and net plug. High precision and low noise, easily setting.

- Essential details
- Usage:-Crimping, Crimping, Crystal head connector crimping
- Application range:-2P2C~8P8C
- Crimping:-Crystal head connector
- Crimping shape:-PC/English or American crystal UTP/telephone crystal UTP
- Weight:-15kg
- Power supply:-60watt
- function:-Crimping crystal connector

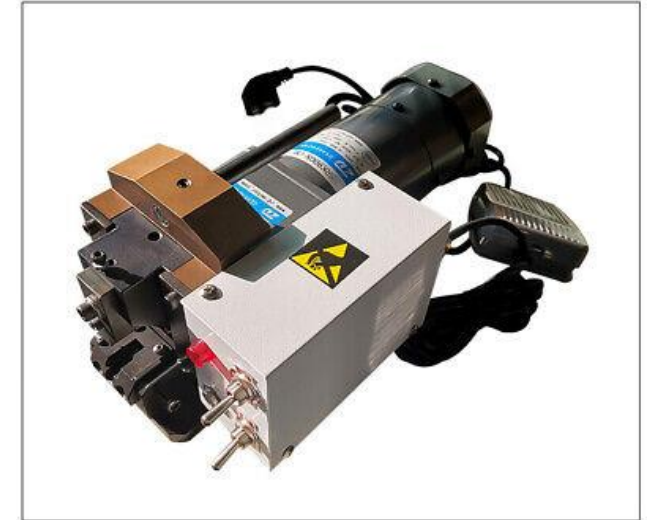

10 Ton Pneumatic Hydraulic Terminal Crimping Machine Terminal Lug Crimp Machine For Electrical Cable



Product Description

- Product name-Numerical Control Hydraulic Terminal Crimping Machine
- Crimp pressure-10 Tons (Max)
- Product accuracy-0.03 MM
- Crimping range-0-95 square
- Product function-Crimping 6
- Product size-400*300*900 MM
- Product weight-120 KG
- Operating voltage-AC220 V / 50 HZ
- Rated power-0.1 KW
- Display mode-4.3-inch touch screen

10 Ton Pneumatic Hydraulic Terminal Crimping Machine Terminal Lug Crimp Machine For Electrical Cable

APPLICABLE DIE USE



Applicable die

A | Open six side free pressing die

Applicable terminal Crimped sample

B | Six side free pressing die

Applicable terminal Crimped sample

C | Open four sides free pressing die

Applicable terminal Crimped sample

D | Crimping die for guide post

Applicable terminal Crimped sam

The hydraulic terminal press is mainly used with six-sided die, four-sided die, four-point die, single die to crimp the large square terminal



6. IE-5055A Automatic 2 pin 3 pin plug insert crimping machine

- **Product Description**
- Model-IE-5055A
- Applicable plug-Two Pin Plug, Three Pin Plug
- Detection Method-Optical fibre amplifier, magnetic switch automatic sensing detection
- Feeding Method-Vibrating plate
- Crimping Force-2-8T
- Control Method-Button/ Foot pedal
- Power Supply-110/220V 50/60HZ
- Capacity-1200pcs/h
- Air Pressure-5-6KGF
- Machine Size-1250*730*1550mm
- Machine Weight-150kg



6. pneumatic cable terminal crimping machine pneumatic crimping tools

Product Description

SA-06M, Pneumatic ferrules crimp tool is suitable for crimping a variety of loose terminals onto cables, Crimp force is 2.0T

- Suitable for crimping a variety of loose tubular terminals onto cables
- Wire crimping can be finished at one time
- The terminals are crimped on all four sides, no need to replace the crimping die
- Vibrating plate feeding, saving time and effort, replacing terminals is convenient and quick
- Fully sealed crimping, safe and reliable

Features

- Model - IE-06M
- Crimping Size - 0.5-10mm²
- Air Pressure - 0.5-0.7MPa
- Crimping Force - 2.0T
- Weight - 4.8KG
- Dimension - 286*125*165mm



Die Set for Selection & Crimping Tools

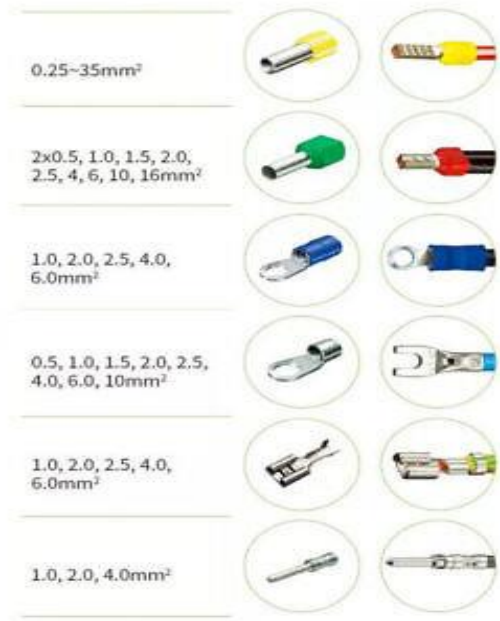

A30J 0.5-6mm ²	A03C 0.5-6mm ²	A-40J 0.25-6mm ²	A07FL 1.25-2.5mm ²	A06WF2C 0.5-2.5mm ²
A04WFL 0.5-4mm ²	A26TW 2x0.5-6mm ²	A16WF 4-16mm ²	A0616WFL 6,10,16mm ²	A625GFL 6-25mm ²
A35WF 10-35mm ²	A03B 1.5-6mm ²	A5516 5.5-16mm ²	A10 1.5-6mm ²	A101 1.5-10mm ²
A10A 1.5-10mm ²	A1016 0.5-16mm ²	A02H 6.5mm/5.4mm 1.7mm	A02H2 8.0mm/6.4mm 1.7mm/1.0mm	A05H 4.5mm/6.5mm/7.0mm 1.7mm/1.0mm
A02H1 8.8mm/8.1mm 6.5mm	A457 5.4mm/8.0mm 11.0mm ²	A05FL / A-FL 4.8-6.3mm ² /4.8mm ²	A1HK 2mm/2.2mm/2.4mm ²	A1050 10A-50A

Wire Harness Tensile Testing Machine Wire Push Pull Tester 1000N

- Features:
- Dimension - 430*180*210(mm)
- Weight - 14Kg
- Power - AC220V/50HZ
- Function - Wire pulling force tester
- Rated load - $\leq 100\text{KG}$
- Precision - $\pm 0.04\text{KG}$



Automatic Computer Wire And Cable Cutting & Stripping Machine

- Features
- Automatic Full Computer Wire Stripping Machine adopt the advanced automation It is a kind of numerical control equipment.
- Apply for Widely used in the electronics industry, the city as, electrical appliances, motor, lamps, toys, and other various products of wire processing.
- Optimal stripped wire PVC/eflon/silica gel line /. Glass fibre, etc.
- Specification:
- Available Wire Cross-Section Range:-0.1~4.5mm²
- Conduit Diameter:-6mm
- Cutting Length:-1~9999mm
- Cutting Tolerance:- $\pm(0.002 \times L)$ (L=Cutting Length)
- Stripping Length:-Head 0~35mm, Tail 0~15mm
- Middle Stripping Section:-Max 11
- Speed: 3000-8000pcs/h
- Display Way: English LCD display Drive Mode: 4 Drives
- Blade Material: Hard tungsten steel
- Appropriate Wire: Electrical wires, PVC/Silica gel line/Glass fibre cables
- Power Supply: 220V/50Hz 110V/60Hz
- Power Rating: 200W
- Measurement: 390X350X255mm
- Weight:32kg



Samples:

Full stripping



Half stripping



All Models of Automatic Computer Wire And Cable Cutting & Stripping Machine

Sample Footer Text

Photo				
Wire range	0.3-25.0mm ²	0.3-25.0mm ²	1-35.0mm ²	1-70.0mm ²
OD of feeding	Ø13	Ø13	Ø16	Ø18
Stripping length	0-50mm	0-100mm	0-150mm	0-150mm
Cutting length	0-50mm	0-10mm	0-150mm	0-150mm
Available wire	1-60000mm	1-100000mm	1-100000mm	1-100000mm
Available wire	Thick wires	8 wheels drive	Thick wires	Super thick wires

Photo				
Wire range	0.1-4.5mm ²	0.1-4.5mm ²	0.1-10.0mm ²	0.1-4.5mm ²
OD of feeding	Ø10	Customized flat	Ø13	Ø8
Stripping length	Head 0-50mm Tail 0-50mm	Head 0-50mm Tail 0-50mm	Head 0-250mm Tail 0-150mm	Head 0-50mm Tail 0-50mm
Cutting length	1-60000mm	1-60000mm	1-100000mm	1-60000mm
Available wire	Round sheath wire	Flat sheath wire	Sheath wires	Coaxial wires

Photo				
Wire range	0.1-2.5mm ²	0.1-20mm tubes	2-12P	2.5-16mm ²
OD of feeding	Ø6	Ø20	Customized flat	Ø10
Stripping length	Head 0-35mm Tail 0-25mm	/	Head 0-15mm Tail 0-15mm	Head 0-20mm Tail 0-20mm
Cutting length	1-100000mm	1-9999mm	1-100000mm	1-100000mm
Available wire	Twisting wires	PVC tubes	Parallel wires	Bending wires

Package:

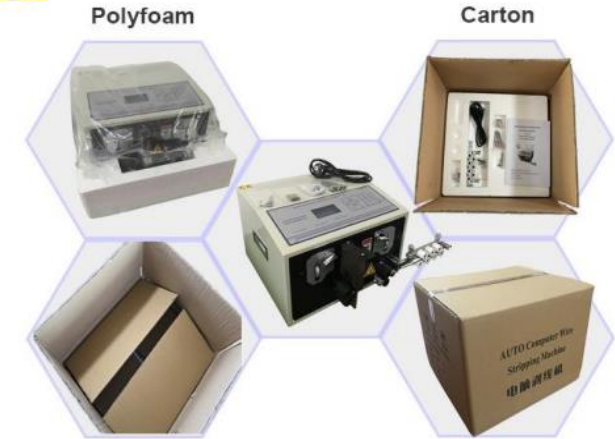

Two cartons

Finished package

All models:

Photo				
Wire range	0.1-2.5mm ²	0.1-4.5mm ²	0.1-2.5mm ²	0.1-2.5mm ²
OD of feeding	Ø6	Ø7	Ø6	Ø6
Stripping length	Head 0-35mm Tail 0-15mm	Head 0-35mm Tail 0-15mm	Head 0-35mm Tail 0-15mm	Head 0-50mm Tail 0-30mm
Cutting length	1-9999mm	1-9999mm	1-9999mm	1-9999mm
Available wire	Small wires	General wires	Double small wires	Double small wires

Photo				
Wire range	0.1-8.0mm ²	0.1-8.0mm ²	0.2-10mm ²	0.2-16.0mm ²
OD of feeding	Ø10	Ø10	Ø13	Ø13
Stripping length	Head 0-35mm Tail 0-15mm	Head 0-50mm Tail 0-50mm	Head 0-80mm Tail 0-80mm	Head 0-50mm Tail 0-50mm
Cutting length	1-9999mm	1-9999mm	1-100000mm	1-60000mm
Available wire	General wires	General wires	Thick wires	Thick wires

.High Quality Flat Wire Computer Cutting And Peeling Machine Multiple Wire Ribbon Cable Stripping Machine

- Essential details
- Model Number: IE-220P
- Name: Automatic cable stripping machine
- Power supply: AC220V/110V 50/60HZ
- Stripping length: head stripping 0.1-50mm, tail stripping 0.1-30mm
- Split line length: Adjustable
- Split mode: Pneumatic dividing line
- Applicable wire multiple number: 2P-24P
- Yield: 2000-8000
- Applicable wire diameter: AWG#16-AWG#32
- After-sales service: On-line Support



Flat wire computer cutting and peeling machine



. Flat sheath wire peeling machine with twisting multi core wire stripper two cords flat cables cut and strip equipment

- Specification:
- Product model-IE220T
- Power supply- AC220V 50/60Hz
- Display-English LCD screen
- Processing wire range-AWG#7-AWG#28 depending
- Stripping length-Front end 1-100, rear 0-60, half 30
- Blade material-Tungsten steel Work speed-1500-2000 pieces/h
- Driveway-Step motor drives 4 wheels simultaneously
- Processable wire-Flat sheathed wire, PVC, VSF, Teflon, glass fibre wire etc.
- Weight-39KG
- Dimension-700*400*380mm

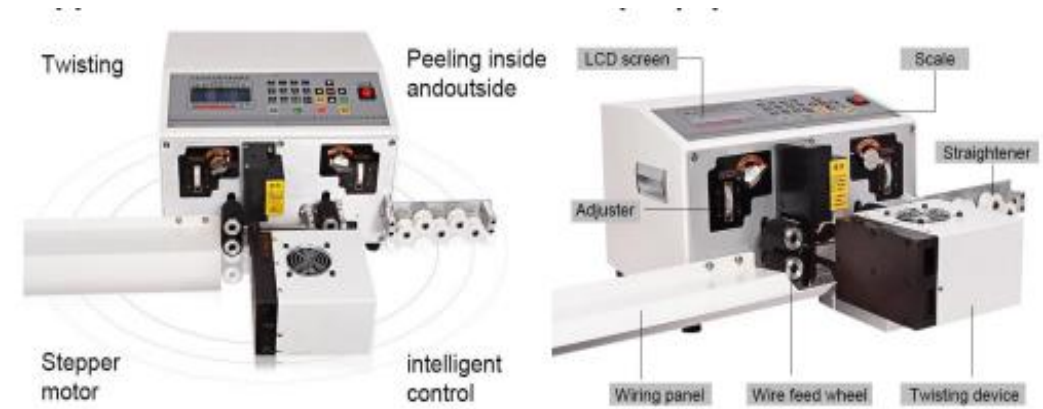

Flat sheath wire stripping the core wire and twisting the wire at one time

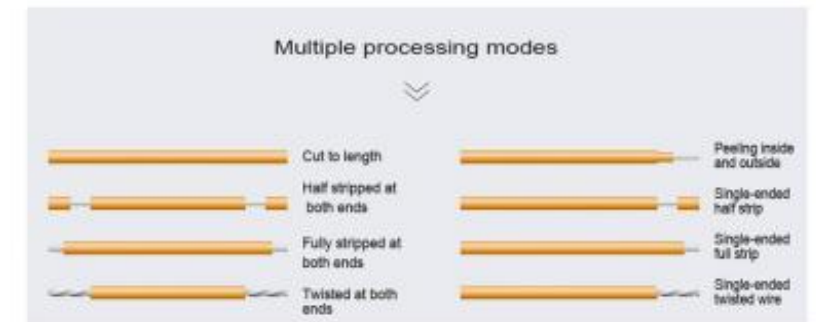

IE-330R Nylon braided wire heating stripping machine USB braided cable cutting stripping machine

- Products Description
- Model IE-330R
- Power- AC220V 50/60HZ
- Wire diameter - AWG22-18(3.2-5.2MM)
- Cutting length - 0.1mm-99999mm
- Stripping length - 2-20mm
- Capacity- 3000pcs/h
- Size- 900*500*600mm
- Weight-65kg



3F pneumatic electrical wire Peeling machine for computer wire and power wire

- 3F pneumatic electrical wire Peeling machine for AC/DC, power cord, sheath wire, computer wire, electronic wire stripper
- Pneumatic control, improved aircraft design, advanced and suitable diameter AWG#18-32#
- double moving cylinder, free of spring breakage.
- The two cylinders of oil and gas self supply provide regular oil supply to cylinder, reduce internal wear and prolong service life
- Unique slide seat, stable reciprocating stroke, accurate cutting and stripping.
- Pneumatic control, light and agile, easy to operate.
- Debug structure, adjust the thickness of the line of sight. It is suitable for the processing of large and small wires and long and short wires.
- Such as AC/DC, power cord, sheath wire, computer wire, electronic wire, multi-core wire, cable, flat line, etc.;

Product parameters

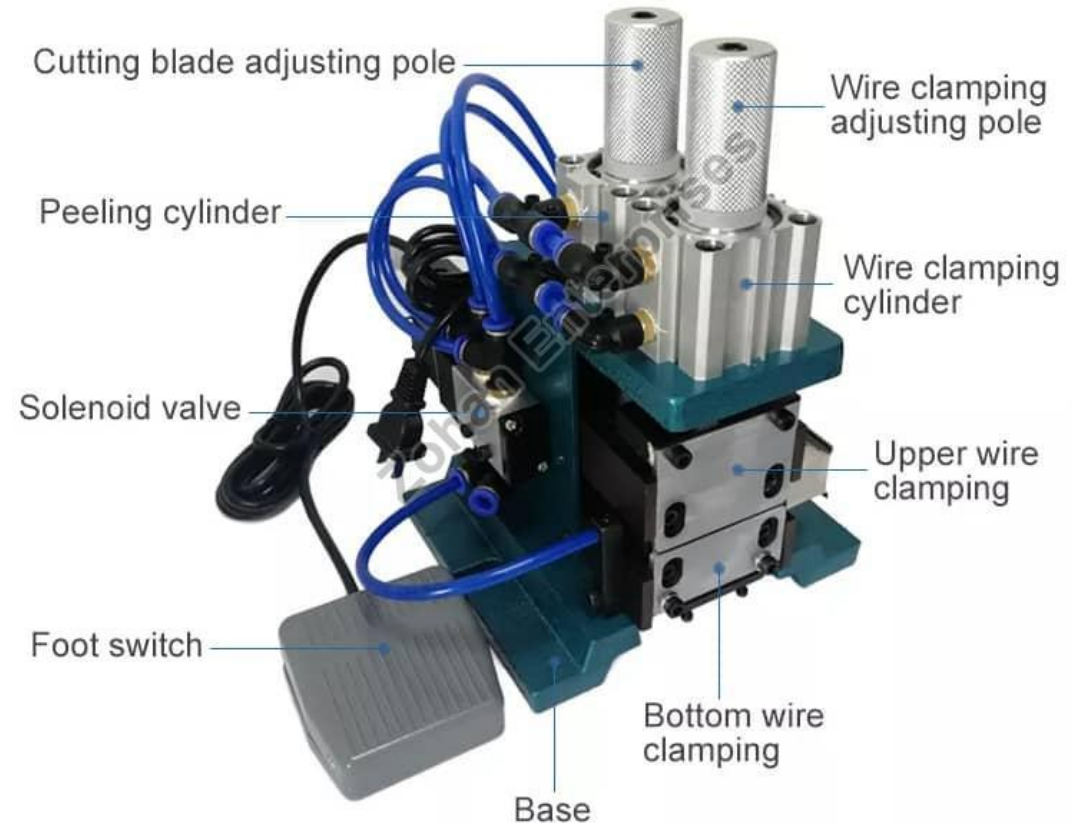

Products Description

- Power supply - AC 220/110V
- Air pressure - 3-7KG
- Stripping diameter -32#-16#
- Stripping length -25mm
- Dimension - 330*190*270mm
- Weight-12K

Product details



Premium blade

Using high-quality wear-resistant blades, durable and long-lasting sharpness

Auxiliary cylinder

The length of the stripping wire is controlled by the valve on the cylinder and the left and right twisting regulating valve to control whether the stripping wire is available
Wound core wire



Pneumatic control

Pneumatic-electric control, improved model, advanced design, applicable wire warp AWG#18-32

Master cylinder

The length of the core wire is controlled by the nut behind the cylinder and the left and right screw nut to control the length of the core wire



3FN Vertical Pneumatic Wire Peeling Machine, Wire Stripper, Wire Cable Stripping Machine

- Specification
- Model - Vertical pneumatic peeling machine / Vertical pneumatic peeling and twisting machine
- Air pressure volume - 4.5-7kg/cm² / 4.5-7kg/cm²
- Stripping / twisting length - 0.5-25mm / 3.0-25mm
- Weight - 13 KG / 1 5KG
- Packing Size - 300*200*280mm / 320x230x300mm
- Power source - 220V 50HZ / 220V 50HZ

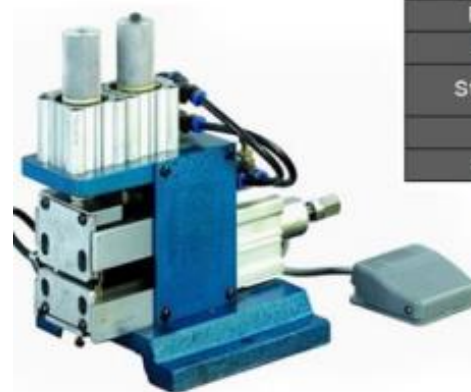
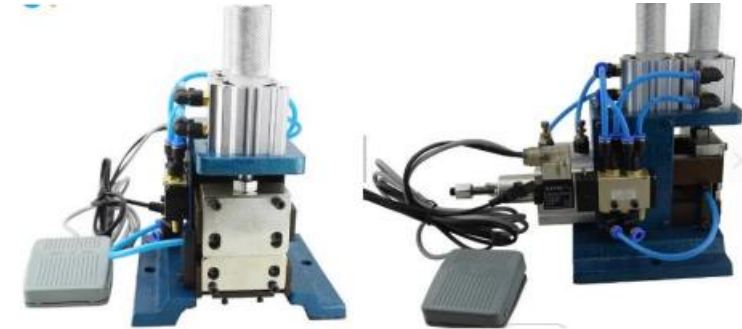

Stripping wire diameter	0.1-2.5mm
Power supply	220V 50HZ
Air pressure	5- 7kg/cm ²
Stripping length	Single knife cutting 25mm Double knife cutting 1.5-5.0mm
Weight	9.5KG
Specification	260x 150x 270mm

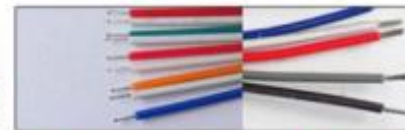

Stripping effect

Blade description & Product Parameter

BLADES DESCRIPTION:

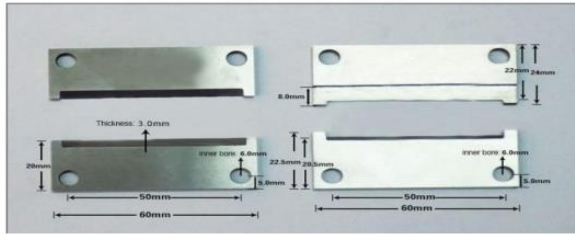

Peeling blade (flat blade)

Cutter blade

The machine comes standard with a set of blades: A set of blades is 4 pieces, 2 stripping blades (flat blades), 2 slice blades. For other blades, please contact customer service.

(Note: The upper cutter is 1.5mm higher than the lower cutter)

Specification

model	air pressure	peeling length	weight	size	power supply
305	3-7kg	2-7mm	17KG	350*280*240	AC110V/220V
310	3-7kg	2-12mm	24KG	450*280*250	AC110V/220V
315	3-7kg	2-15mm	28KG	560*320*280	AC110V/220V
330	4-8kg	2-15mm	55KG	850*400*320	AC110V/220V
416	3-7kg	2-30mm	50KG	600*420*370	AC110V/220V
3f	5-7kg	25mm	13KG	260*150*270	AC110V/220V
3fn	4-7.5kg	25mm	15KG	320*320*300	AC110V/220V
4f	5-7kg	25mm	15KG	280*220*280	AC110V/220V
4fn	4-7.5kg	25mm	19KG	320*230*350	AC110V/220V

PRODUCT PARAMETER

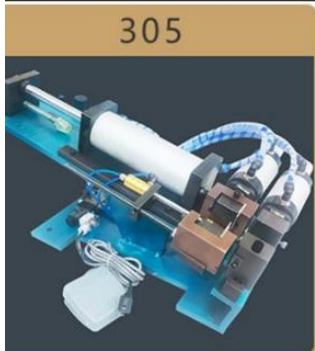

Electric power cable pneumatic wire stripping and cutting machine 305 pneumatic stripper

Product Description

- Pneumatic electric heated wire stripper machine
- The machine is suitable for small to medium coarse multiconductor, telephone lines, computer lines, power cords, side by side stripping twisting line processing.
- Delicate design makes the machine structure is compact, small, simple operation. Multiple synchronous torsion function on doubling the efficiency, quality, more perfect.
- This machine is compared with other similar products more superior performance, affordable.
- It can stripping twisting cable wire.

Parameters

- Electric wire cutting and stripping/peeling machine Jumpered Wire stripping forming machine
- Model WL-305
- Stroke 50MM
- Stripping Length - 0-50mm
- Air Pressure - 3-7kgcm²
- Voltage Ac220V/50Hz Force 31-37kg
- Cylinder 40
- Weight 20kg
- Size 400x300x270mm

Product details

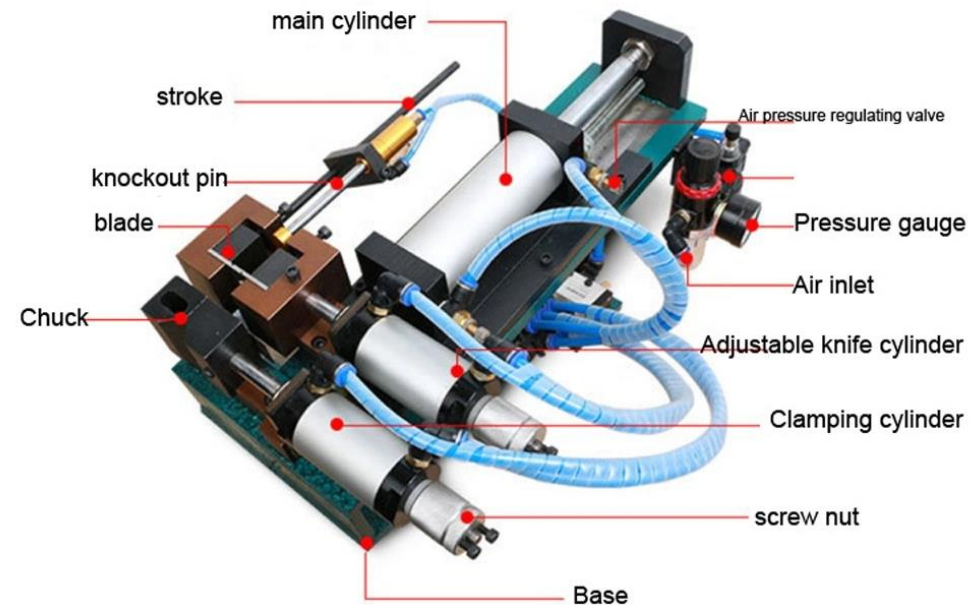

Automatic Wire Cable Feeding Machine Wire Pay Off Machine

Specification

- Model -IE-14C
- Feeding roller motor -120W
- Wire tray motor - 180W
- Transmission speed - 10 , automatic induction brake
- Max. Loading weight - 20kgs
- Machine size - 700*802*1025mm

Application

Wire Feeder + Wire Cut Strip Machine + Wire Collection Device



Cable feeding machine cable pay off reel automatic wire feeder

Specification

- Model Number: Cable pay-off tray
- Usage: Multifunctional
- Name: wire feeding machine
- Keywords: wire feeding machine Automatic Wire Feeder for Wire Stripping Machine
- Weight: 10kg
- Power: 220V 50Hz
- Function: feeding wire
- Coil outer diameter: 38cm

WIRE SAMPLE SHOW

WIRE FEEDING GROUP

It can be used with most wire harness equipment, and is suitable for most electronic wires except flattened parallel wires or flat wires



Manual Round Bottle Labeling Machine Beer Cans Wine Adhesive Sticker Labeler Label Dispenser Machine Packing Machine

- Manual Bottle Labeling Machine

1.This desktop bottle label machine can save space and easy to use

2.Suitable for round bottles: adjust the distance between the two rolls to fit the bottle

3.Manual type: with no need for connecting power and save energy

Product Description

- Labeling speed - 30Pcs/min
- Precision - ± 0.5 mm
- Label size - Length:10-300mm Width:10-110mm
- Label Roll Out diameter - ≤ 150 mm
- Label roll inner diameter - ≥ 75 mm
- Product size - Diameter:15-120mm
- Height:- 150mm max
- Machine size - 400*240*240mm 4.5KG
- Power - No need

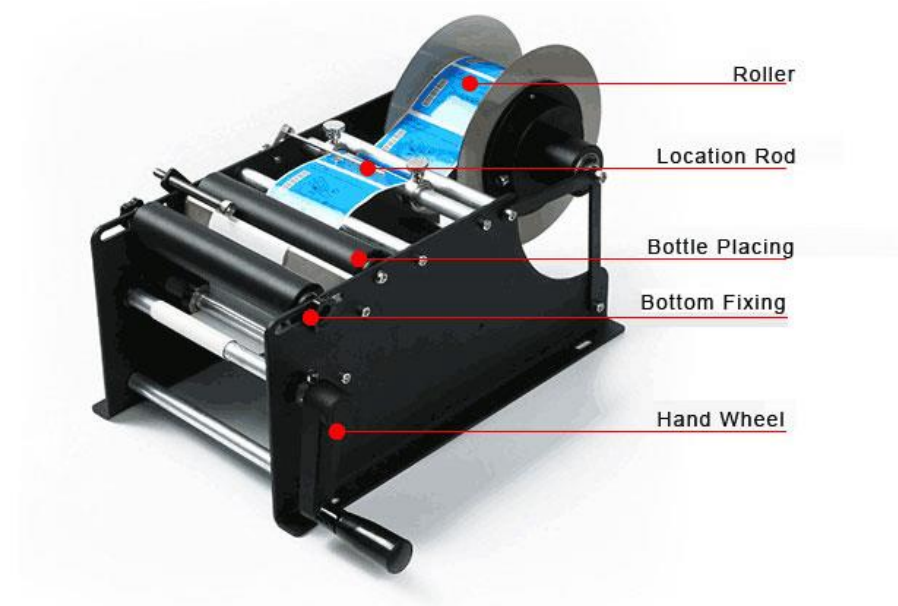

1150D auto label dispenser price label stripping machine

Features

- Ideal for small labels and small work areas
- Will dispense labels and die-cut parts
- Photosensor Accuracy and Reliability
- Automatically removes paper, vinyl, acetate, polyester, foil, etc. from its liner
- Automatically rewinds liner scrap for a cleaner working environment
- No tools required for adjusting to different size labels
- No maintenance required
- High Torque Motor for large diameter label rolls

Specifications

- Display:- 6 digit LED
- Applicable Label Width: - From 5mm to 140mm
- Label Height Limit: - 4 - 140mm
- Core and Roll Size: Internal Diameter: 25-75mm Outside Diameter: Less than 250mm
- Feed Speed - From 16mm to 130mm/s
- Power: - AC110V 60Hz / AC220V 50Hz
- Dimensions & Weight: - 210(W) x 210(L) x 220(H)mm 4.5kg
- Can not use - Transparent label, Reflective label



Manual/Automatic Sticker Label Dispenser Machine Barcode Peel Dispenser

Specification

- Product Name - label dispenser
- Driven Type - Manual/Automatic
- Dimension(L*W*H) - (L)29.5CM*(W)17CM*(H)29CM
- Max Paper width - 210mm
- Labeling speed - Manul adjustable
- After-sales Service - Online support, No overseas service provided
- Standard core - 3 inch
- Weight - 3.5KG
- Key Selling Points - Green lamp power indicator



Automatic table label rewinding barcode label rewinding

MODEL NO.	R-7	R-9
Max Speed	8inch/s	12inch/s
Rewind Diameter	10-185mm	10-220mm
Rewind Wirth	110mm	120mm
Rewinder Core Size	1-3 inch adjustable	1-4 inch adjustable
Rewind Way	Automatically match with printer speed	<ol style="list-style-type: none"> 1. Automatically match with printer speed 2. speed governor to adjust speed
Working Intensity	24 hours continuous working Low temper working	24 hours continuous working Low temper working
Power Supply	110V-240V 50/60HZ, 12VDC 1A	110V-240V 50/60HZ, 12VDC 1A
Machine Size	180*185*200mm,5kg	340*200*260,6.5kg

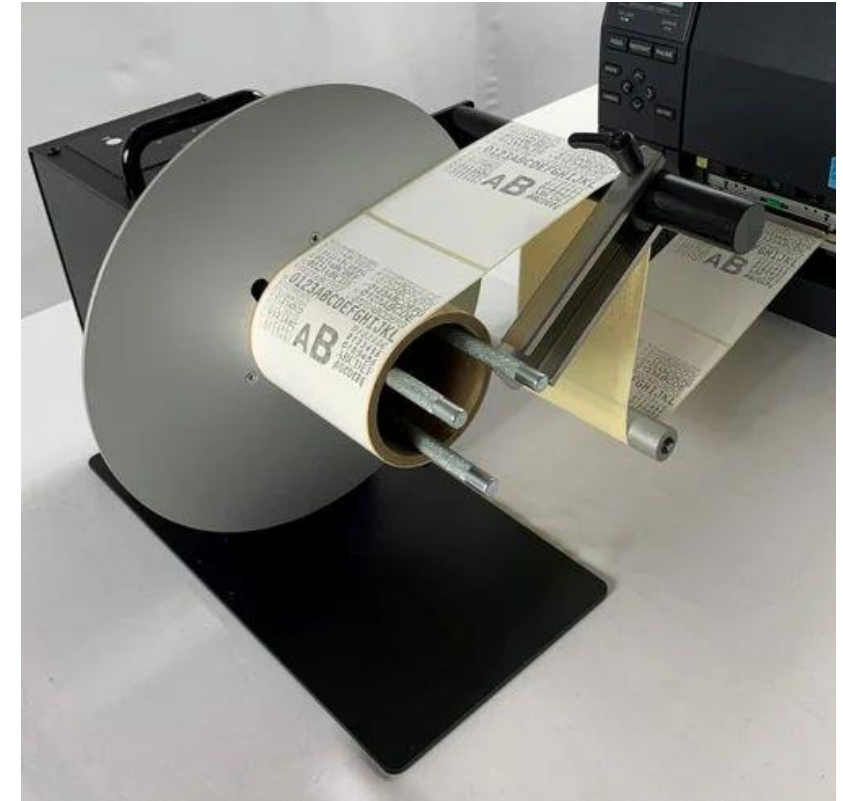

Electrical Label Dispenser AL-505 SERIES

Product Description Features:

- Ideal for small labels and small work areas
- Will dispense labels and die-cut parts
- Photosensor Accuracy and Reliability
- Automatically removes paper, vinyl, acetate, polyester, foil, etc. from its liner
- Automatically rewinds liner scrap for a cleaner working environment
- No tools required for adjusting to different size labels
- No maintenance required
- High Torque Motor for large diameter label rolls
- Feature: LCD counter can show how many labels has been dispensed.
- Specifications:
- Available Width: 4 ~ 160mm
- Available Length: 4 ~ 300mm
- Feed Speed: 5m/min
- Max. OD of Roll: 250mm
- Power Supply: AC110V 60Hz / AC220V 50Hz
- Measurement & Weight: 260*248*208mm 5.0Kg



Model No.	Label Width	Label Length	Dimensions	Weight
AL-505S	4-70mm	4-100mm	200*145*140mm	4.5kg
AL-505M	4-120mm	4-300mm	260*208*208mm	5.0kg
AL-505L	4-160mm	4-300mm	260*208*208mm	5.0kg
AL-505XL	4-200mm	4-300mm	260*288*208mm	6.0kg

High Quality Automatic Label Dispenser X-130 Label Peeling Machine

Function

- Ideal for small labels and small work areas
- Will dispense label and die-cut parts
- Photosensor Accuracy and Reliability
- Automatically removes paper, vinyl, acetate, polyester, foil, etc. from its liner
- Automatically rewinds liner scrap for a cleaner working environment
- No tools required for adjusting to different size labels
- No maintenance required
- High torque motor for large diameter label rolls
- Feature: LCD counter can show how many labels has been dispensed
- Dimensions -166(W)*174(H)*280(D)mm
- Feed Speed -130mm/C
- Available Lable Width 5-130mm
- Roll Capacity-- 250mm in dia
- Lable Material - Any material can be used



Model	AL1150D	X-100	X-130	X-180
Photo				
Machine	Label dispenser	Label dispenser	Label dispenser	Label dispenser
Label width	10 ~ 140mm	5 ~ 100mm	5 ~ 130mm	5 ~ 180mm
Label length	4 ~ 200mm	5 ~ 300mm	5 ~ 300mm	5 ~ 300mm
Measurement	210*210*220mm	136*174*280mm	166*174*280mm	300*350*320mm
Weight	5.5Kg	4.0Kg	5.0	7.5Kg

Label Sticking Machine For Round Bottle Manual Labeling Machine Wine Bottle Sticker Label Small Packing Machine

Specifications:

- product Name - Semi-automatic round bottle labelling machine
- Labelling Speed 20-40PCS/min
- power Supply 220V, 50/60Hz, 100W
- Container Diameter 15-120mm
- Label Size W26L25 - W150L300
- Label Roll Inner Diameter - 75mm
- Label Roll Outer Diameter - 275mm
- Machine Size 650 × 345 × 450mm



Product applicability

All kinds of round bottles are self-adhesive labeling, can be positioned



Small desktop label dispenser machine wine bottle label pasting machine semi-automatic round bottle labeling machine

- Round Bottle Labeling Machine
- Intelligent operation panel: Easy to adjust the working data
- Can be equipped with code printer, make labeling and printing time and batch at one machine
- Labeling speed: 20-40 pieces/minute, which is adjustable, improve the working efficiency greatly
- Labeling function: full/half circumference labeling, circumferential front and back labeling, front and back label spacing can be adjusted at will
- Two working mode: pedal switch control or automatic working mode.

Product Parameters

- Bottle Diameter - 15mm-160mm
- Bottle Height - 15mm-380mm
- Label Length - 10mm-360mm
- Label Bottom Paper Width - 10mm -230mm
- Labeling Accuracy - ± 0.5 mm
- Labeling Speed - 20-40 pieces/minute
- Inner Diameter of Label Roll - $\Phi 76$ mm
- Outer Diameter of Label Roll - $\Phi 280$ mm
- Machine Size - About 750mm \times 620mm \times 680mm Machine Weight - 45kgs
- Voltage - 110-230V

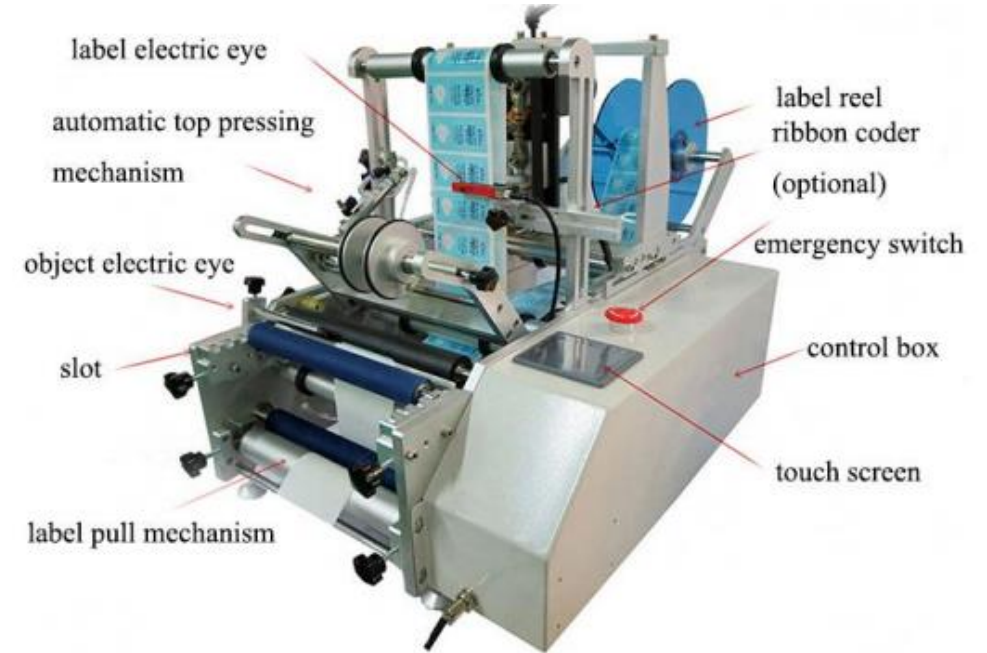

Suitable For Bottles Of Various Diameters

Bottles Diameter Within 15-160mm Can Be Used,
We Can Also Customize According To Customer Demand



Multifunction Automatical Label Cutting Machine Hot and Cold Option

Essential details

- Name - Fabric Ribbon Cutting Machine
- Core Components - PLC
- Application - Machinery & Hardware, Making Disposable
- Automatic Grade - Automatic
- Driven Type - Electric
- Voltage - 220v
- Power - 400w
- Weight - 30kg
- Dimension(L*W*H) - 560mmx415mmx400mm

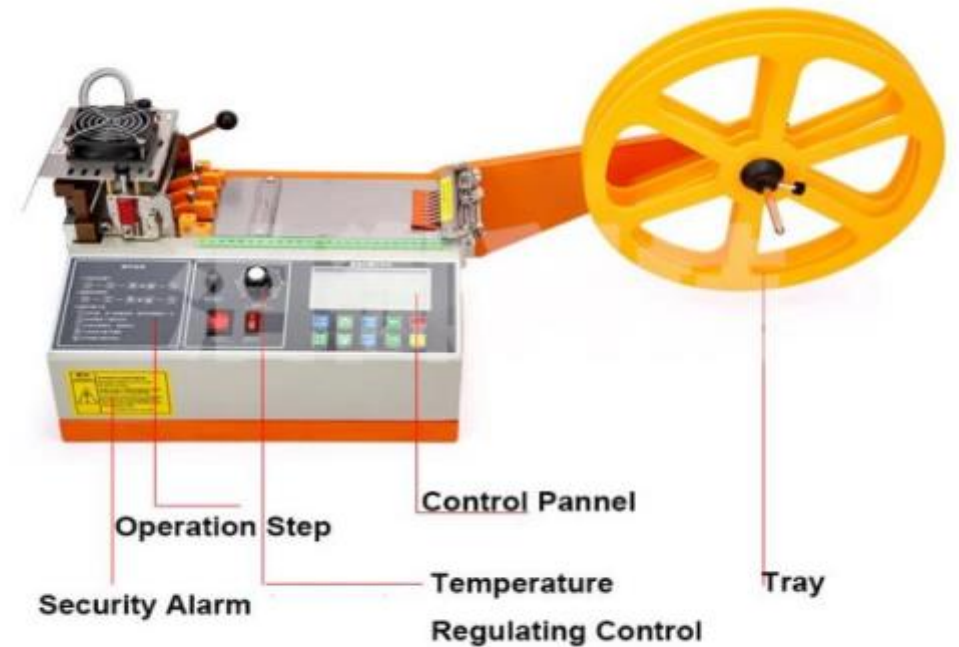

Woven Label Cut and Fold Machine / Garment Fabric Wash Care Label Cutting and Folding Machine for Polyester Satin Ribbon

- Features of Label Cutting & Folding Machine
- It can be cutting & folding belt materials such as polyester satin, cotton tape, nylon taffeta and woven labels.
- It is suitable for end folding, short and long folding, center folding, envelop folding and piece cut.
- model is easy to operate and has superb performance. It is designed especially for with soft labels and its smooth operate.
- Equipped with a photo electronic fault eliminator that can reduce defective cutting and folding to the lowest possible.

Main Technical Variables:

Fold type	Narrowest	Widest	Shortest	Longest
End fold	10mm	55mm	30mm	180mm
Centre fold	10mm	55mm	18mm	75mm
Envelop fold	10mm	25mm	30mm	130mm

Fold label speed: 200pcs/min

Cutting label speed (piece cut) :200pcs/min

Power: AC: 200V~240V 15A/50Hz~60Hz

Output: 3KW

Weight:300KG

Dimension:1200x1380x1560 MM (L*W*H)



Small Vertical PVC Plastic Injection Molding Machine

Product Description

1. Vertical mold opening, vertical injection, suitable for insert molding
2. Nitrided steel screw, material tube, high torque hydraulic motor drive, multistage injection pressure, good plasticizing performance.
3. Direct pressure mother-mold lock cylinder design, rapid mold clamping, low pressure safety mold clamping, automatic mold closing, multiple pressure control, high safety and improved mold life.
4. Electrical protection device, no mistakes, maintenance operator safety.
5. Automatic fault display, maintenance is quick and easy.
6. Electronic control and hydraulic use brand-name parts, quiet, precise and durable.
7. Multi-stage temperature control, multi-stage injection pressure, rate of fire, back pressure stepless adjustment, suitable for molding of precision plastic parts.
8. Optional servo energy-saving motor.
9. This machine offers a wide range of programmable functions including automatic inclusion, extraction and fully-automatic production.
10. Two column and four column (option)



Description

Injection system	Screw diameter	mm	20	25	28	30
	Injection pressure	Kg/cm ²	1715	1164	816	886
	Theoretical shot volume	cm ³	31	49	56	70
	Max.injection weight(PS)	g	29	60	80	84
	Injection rate	cm ³ /sec	20	30	30	68
	Screw stroke	mm	100			
	Max.screw speed	rpm	0-155			0-205
	Nozzle contact force	tons	2.0			2.4
	Nozzle retraction stroke	mm	133	140	165	
	Number of temperature control	-	1+2			
	Material hopper capacity	L	15	15	20	
Clamping System	Clamping Force	tons	15	20	30	
	Opening Force	tons	7	7	6.5	
	Platen Size	mm	450*290	460*310	520*370	
	Distance Between Tie Bare	mm	280*140	303*153	350*205	
	Min. Mold Height	mm	140/80	160/100	160/100	
	Opening Stroke	mm	160	180	180	
	Max. Open Daylight	mm	300/240	340/280	340/280	
	Ejector Force	tons	1.3	1.3	1.3	
	Ejector Stroke	mm	35	35	35	
Sliding System	Slide Stroke	mm	-	-	-	
	Max. Mold Weight	kg	-	-	-	
	Station Clearance	mm	-	-	-	
Hydraulic Power System	Max. Hydraulic Pressure	Kg/cm ² (mPa)	140	140	140	
	Pump Output	L/min	23	23	26	
	Oil Reservoir Capacity	L	80	80	100	
	Cooling Water Consumption	/hr	400-600	400-600	400-600	
	Pump Motor Power	KW	3.5	4	4	
	Barrel Heating Power	KW	2.2	2	2.7	
	Total Wattage	KW	5.5	6	6.2	
Others	Machine Weight	tons	0.68/0.8	0.68/0.8	1.1/1.3	
	Machine Dimensions L*W*H	mm	1550*900*2350	1400*900*2200	1570*950*2350	
	Shipping Weight	tons	0.8/0.9	0.88/0.9	1.3/1.5	
	Shipping Measurements L*W*H	mm	1750*1050*2400	1500*1000*2300	1670*1050*2450	

APPLICATION



Hot Sales USB Cable Injection Molding Machine Vertical Plastic Injection Machine

Injection Unit										
Screw Diameter	mm	22	28	32	28	32	36	32	36	40
Theoretical Injection Volume	cm ³	53	86	112	86	112	142	112	142	175
Injection Weight	g	49	80	104	80	104	132	104	132	163
Max. Injection Pressure	Mpa	248	153	117	212	162	128	228	180	146
Injection Rate	cm ³ /s	44	71	93	63	83	105	85	108	133
Injection Speed	mm/s	116			103			106		
Screw Speed Rotation	r.p.m	0-240			0-240			0-271		
Nozzle Out From Platens	mm	≥45			≥45			≥45		
Clamping Unit										
Clamping Force	KN	343/441			539			833/980		
Clamping Stroke	mm	200			200			250		
Ejector Force	KN	17.2			17.2			26.5		
Others										
System Pressure	Mpa	13.7			13.7			13.7		
Oil Tank Capacity	L	130			140			280		
Motor Power	Kw	5.5/7.5			7.5			15/18.5/servo 11		
Heater Power	Kw	3.6			5.5			6.4		



Applications



Laminated Tube Head Injection Molding Machine

Main Features

- 1) Double-mode alternate forming
- 2) Screw pre-plasticization, fixed and limited feeding, full hydraulic fast and slow mold closing
- 3) High mold clamping force
- 4) Smooth mold movement
- 5) Electric interlocking
- 6) Small floor space, easy mold assembly and disassembly
- 7) Named-brand parts and best body-building metal materials



Main technical parameters

Machine main motor power	5.5kw	Molding opening force	100kN
Heating power	3.5kw	Max Production capacity	22-24pcs/min
Injection weight	63cm ³	Dimension	2300*1700*2800mm
Injection power	136MPa	Weight	1300kg
Molding clamping force	400kN		

IE-25 Injection Molding Machine Desktop Plastic Extruder Machine Desktop Polymer Material Single Screw Small Extruder

Essential details

- Plastic Processed: PE, PP, PVC, ABS, Polystyrene, PA, EVA, FRPP/PVC, HDPE
- Application: Bar, Wire, PIPE, Granules, Sheet, Film, Plates, Filament
- Screw Design: Single-screw
- Screw Material: 38CrMoALA
- Screw diameter (mm): 25mm
- Screw L/D Ratio: 14:1
- Screw Speed (rpm): 70 rpm
- Voltage: 220V
- Dimension(L*W*H): 0.7*0.3*0.5
- Power (kW): 0.25
- Weight: 30 KG
- Key Selling Points: Easy to Operate
- Applicable Industries: Hotels, Garment Shops, Building Material Shops, Manufacturing Plant, Machinery Repair Shops
- Core Components: Motor, Screw
- maximum output: 1-2KG/hour
- Material of screw and barrel: 38CrMoALA nitriding treatment
- Center height of extruder: 300mm
- Production direction: from right to left
- Power supply voltage: 220V according to customer voltage

Product features



Applicable to all kinds of plastic particles. PP PVC.etc

Used for plastic color mixing test3D printer wire extrusion,etc

Screw for variable diameter injection molding machine

Variable diameter screw can better mix and extrude evenly

The presence of chromophores is particularly evident Extrusion port 3mm

Applicable to all kinds of plastic particles, PP PVC, etc



Variable diameter screw can better mix and extrude evenly



Semi Automatic USB Data Wire Cable Soldering Machine with Cutting and Stripping Functions



- Model - IE-6020-1 or IE-6020-2
- Power - 160W - 160W
- Voltage - 220V/50hz - 220V/50hz
- Working mode - Electric – Pneumatic
- Machine size - 40*40*45cm - 40*40*45cm
- Net Weight - 20KG - 20KG

High accuracy Type C cable welding machine Iphone USB A head automatic DIY soldering machine

- Essential details
- Type: Soldering Machine
- Applicable Industries: Hotels, Garment Shops, Building Material Shops, Machinery Repair Shops, Manufacturing Plant, Food & Beverage Factory, Farms, Restaurant, Home Use, Retail, Food Shop, Printing Shops, Construction works , Energy & Mining, Food & Beverage Shops, Other, Advertising Company
- Video outgoing-inspection: Provided
- Machinery Test Report: Provided
- Core Components: Motor
- Voltage: DC15/3A
- Dimensions: 40*30*30
- Usage: USB cable making machine
- Weight (KG): 26 KG
- Power MIX: less than 150W
- Welding mode: 2 modes are set according to work
- Ambient temperature: 0-50 degree



Semi-automatic Soldering Machine, 15v/3A for Aux, Dc, Usb, Led Lights, Power Plug Switch Spot Welding Machine

- Model : IE-003C
- Name : Semi-Automatic soldering machine
- Power : MIX <150w
- Input voltage : DC 15V/3A
- Welding mode : 2 modes are set according to work
- Ambient temperature : 0-50°C
- Use environment humidity : 0-70%
- Equipment materials : Aluminium alloy
- Size : 400* 300*300mm
- Wight : 9kg

Processing sample display

This product is specially designed for the welding of switches, LED lights, terminals, resistance sensors, thermistors, sensors, aviation heads, etc....circuit boards and wiring harnesses



Semi Automatic USB Data Wire Cable Soldering Machine with Cutting and Stripping Functions

- Welding display
- Product features of semi-automatic wire bonding machine:
 - PLC + touch screen design is easy to operate
 - Fast soldering speed, can weld multiple solder joints at once
 - Strong versatility, the soldering time and the amount of tin can be adjusted, and only different fixtures can be replaced to weld different products
 - Novices can also work proficiently.
 - Widely used in various USB connectors, PCB boards, lamp boards, electronic components, switches, motors, microphones, triodes, LED lights, connectors and other products.
 - Can fit for 90w./150W/200W /1500W different power and so on

BBA



Product parameters

Product name	Semi-automatic welding machine (with peeling function)
Power supply	AC220V 50/60Hz
Power	150w
Air pressure	0.4~0.8MPA
Range of temperature	50~500°
Capacity	300PCS/H
Size	620x390x460
Weight	35KG

Automatic USB wire connector soldering data cable making machine

Product Description

- Compact structure design , high precision and low defective rate
- High productivity 1200-1500 Pcs/H,
- times than soldering by hands, One machine can replace 4 workers
- High stability of the machine , easy to operate
- Constant temperature soldering iron temperature display
- Semi-automatic or fully automatic operation mode (semi-automatic foot switch and infrared induction).
- High quality of the welded products is stable, without false soldering or continuous soldering, tin spot is full and fastness

Specification Of Automatic USB wire connector soldering data cable making machine

- Voltage-220V
- Power-200W
- Air Pressure-0.4-0.8 MPA
- Productivity-1200-1500 PCS /H
- Temp Control Model-Constant Temperature
- Soldering Material-Soldering Wire
- Soldering Angle-90° Weight-About 160KG
- Size-130*60*110CM



ZCUT-9 Automatic Tape Dispensers

Product Description

- 1.It can be used in various sizes tape volumes without roller.
- 2.Set free cutting length of tape from .5 to 999mm
- 3.Memory function (can be free to set up six different length of demand before operation).
- 4.Default, circulation and work count function.
- 5.It can cut two rolls of tape at the same time.
- 6.Built-in double sensors,pliers, lubricating oil, partition for simple operation.
- 7.It can be applied in protective film, aluminum foil and copper foil, insulation material etc
- 8.It can be used to cut Fiber sericin belt, hard tape, acetate, glass wall paper, double-sided adhesive, nomex, sealing glue, transparent tape, process tape, masking tape and plastic tape, etc and No viscous material: protective film, the aluminum foil and copper foil, film, plastic material etc

Specification

- Available Width-6 - 60mm
- Available Length-5 - 999mm
- Tape transfer speed-200 mm/SEC
- Tape out diameter-Max 300 mm
- Body material-prevent charged ABS resin
- Accessories-power cord, 2A fuse (built-in AC plug), separator, guide plate, tweezers and, blade oil ☑
- Power Supply-AC110V/220V 50/60Hz 18W
- Size-213×140×116mm
- Weight-2.5Kg .



ZCUT-2 Automatic Tape Cutting Cutter Packaging Machine

Advantage

Cutting size: 11-58mm Tape width: 3-22mm
Internal Diameter: 25mm/32mm/75mm (1 inch /1.3 inch /3 inch) Outside Diameter: 130mm (5.1 inch) Features: Automatic tape Dispenser can be set according to the length of the cut, and cut off the tape straight, parallel To paste on the edge, Adhesive tape cutting length, paste the interval can be adjusted freely according to user needs. Cutting speed adjustment Cutting length adjustment Automatic cutting and arrange fitly Upgrade, anti-blade mutual card, anti-blocking

Specification

- Model:-ZCUT-2
- Adhesive tape cutting length:-13-59mm
- Adhesive tape cutting width:-3-25mm
- Tape the maximum diameter:-130mm
- Body material:-ABS



Heavy Duty Electronic Electric Packing Tape Dispenser IE-80

Specifications:

- Tape Width:20-80mm
- Tape Length :5-999mm
- Usable Tapes: various film, adhesive tape, non-adhesive tape, double sided tape
- Max.Feeding Speed:200 mm /sec.
- Max. Outside Dia. of Roll:300m
- Power Requirement: AC110/220V.50/60HZ.25W
- Dimensions:190(W)x140(H)x230(D)mm

Features:

- Cutting width: Max.80mm
- Applied tapes: various film, adhesive tape, non-adhesive tape, double sided tape.
- Economic and practical, greatly reduce the production cost
- Operation modes: Auto/Manual



M1000 Electronic Automatic Adhesive Tape Dispenser 7-50m

Product Features.

- Freely adjust length, digital display.
- The M1000 tape dispenser have the option automatic and manual.
- Can have set Length setting memory function.
- With tape sensor function: automatically lead out tape.

Specifications:

- Voltage-220V/50HZ 110V/60HZ
- Usable tape inner Dia.-75/32/25mm
- Power-18W ☑ Usable tape max. Outer Dia.-150mm
- Product size-137(W)*150(H)*218(D)mm
- Usable tape width-7mm-50mm
- G.W-3 KG
- Tape Cutting length-20-999mm
- Packing size-30*20*20cm
- Cutting model-manual and auto



Auto Tape Dispenser ZCUT-2 tape cutting machine

Specifications

- Source power - 220V+5V 50/60HZ 6A
- Input power - 1500-2500W (Can adjustable)
- Output frequency - 20KHz
- Working speed - 0- 20m/min
- Roller size Width :- 0-100mm ; Diameter : $\phi 50-\phi 60$ mm
- Dimension(L*WH) - 1200*600*1 200mm
- Net weight - 105KG
- Working temperature - $\leq 25^{\circ}\text{C}$



Electric Gummed Paper Tape Dispenser water activated paper tape machine

- Specification
- Model:-Gummed paper tape machine
- Size:-45*33*28CM
- Weight:-18KG
- Power:-500W, AC 110 / 220V
- Rate:-150W
- Speed:-30cm/s
- Type Length:-15cm to 210cm, any length
- Advantages:
 - Tape can be fixed in length and outputted automatically .
 - 30cm tape can be produced per second.
- Multi working mode:
 - Single mode: select different length to produce the selected length tape.
 - Automatic mode: select one length and all the rest with same length to be produced automatically.
 - Fixed mode: select several different sizes and produce the tapes as per the setting order.
 - Manual mode: Press and hold to produce the tape continuously
 - Brush position with heating function to enhance brushing effect.
 - Powered off automatically when cover open ;
 - The display shows the current paper output length;
 - Size can be adjusted slightly



Automotive wiring harness pvc tube cutting machine heat shrink sleeve cutting machine IE-100S

Product Description

- Material - PVC Sleeve
- Capacity - as per actual
- Model Name/Number - IE-100
- Model Number:IE-100
- Usage:Cutting-Cut shrink tubing,pvc tube, sleeve, nickel strip,wire,etc
- Name:Heat shrink pvc sleeve cutting
- machineType:AutomaticCut
- length:1-9999mmBlade length:100mm
- Voltage:220V/110V 50Hz/60Hz
- Power:250WCut
- speed:100~120 cuts/min (50mm length)

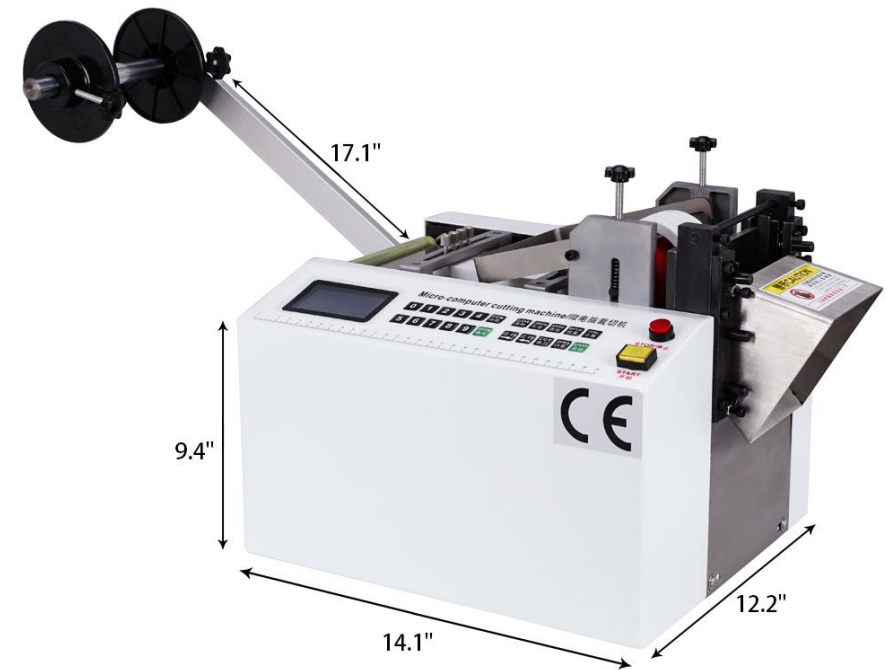

High accuracy shrink tubing cutting Paper sleeve cutting machine

- Product Specification

1. Suitable for cutting heat shrinkable tube/silicone tube/plastic hose/nylon tube etc.
2. It adopts special mechanical structure and special cutting tool, with special software control.
3. The length of cutting tube is controlled by high speed stepper motor, the speed can be adjusted by microcomputer.
4. The computerized pipe cutting machine is controlled by microcomputer program, with high precision of 0.1 mm.
5. High speed feeding, cutter speed adjustable, English OS interface, LCD display.
6. Speed and length are Continuously adjustable by yourself.
7. Grouping, total and counting automatically
8. Batch time-out, delay, time are settable.
9. Lack of tubes stop automatically
10. It can cut automatically all kinds of tubes and belt material. ☑
11. There are many functions: Cutter time protection, total setting, handle setting, adjustable group time.
12. There are various manual operation mode which is very convenient to adjust.
13. Microcomputer pipe cutting machine has large LCD English display screen which is very convenient to operate.
14. Special mechanical structure and special cutting tools are adopted and controlled by special software which solved the problem of unsmooth pipe orifice, the cutting is smooth and the length is accurate.
15. Cutting length 1~9999.9mm



Product Description

- Cutting width - 1-100mm, 1-120mm, 1-160mm (Customizable width)
- Cutting speed - 100-120pcs/min
- Storage specifications - 100
- Cutting Accuracy - ± 0.1 mm
- Power Supply - 220V
- Power consumption - 60W
- Weight - 35KG
- Dimension - 500*450*450mm(L*W*H)

Automatic rubber sleeve cutter corrugated pipe processing equipment cutting machines for tube

Machine Introduction

A versatile and reliable machine for cutting to length heat shrink tubing, plastic piping, sleeving, cable marker tube, small bellows pipe, plastic hose, insulation paper, cable ties, copper foil and so on.

- IE-U10: Multifunction flat material cutting machine, for soft pipe heats hrinkable tube and so on
- IE-U11: Universal tube cutting machine, for soft pipe, hard pipe and so on
- IE-U12: Powerful universal cutting machine, for hard materials, wire, cable, steel wire
- IE-F01: Precision cutting flat materials
- IE-U02: Precision cutting corrugated tube, splitting function can custom
- IE-R03: Rotary cutting hard tube, for hard materials tube
- IE-A04: All in one corrugated tube cut machine, with feeder for long corrugated tube
- IE-M05: Powerful corrugated tube cut machine, for thin metal tube or thick plastic tube
- IE-P06/V07: Visual orientation tube cut machine, precision cut bellows wave valley or peak



Cutting Material Sample

<p>IE-U10</p> <p>Multifunction flat material cutting machine For soft pipe heatshrinkable tube and so on Max Width: 95mm (Custom available)</p>	<p>IE-U11</p> <p>Universal tube cutting machine For soft pipe, hard pipe and so on Dia:1-15mm (Custom available)</p>	<p>IE-U12</p> <p>Powerful universal cutting machine For hard materials, wire, cable, steel wire Size: 95mm * 15mm</p>
		
<p>IE-F01</p> <p>Precision cutting flat materials Max Width: 100mm (Custom available)</p>	<p>IE-U02</p> <p>Precision cutting corrugated tube Splitting function can custom Dia: 4-30mm (Custom available)</p>	<p>IE-R03</p> <p>Rotary cutting hard tube For hard materials tube Dia: 4-30mm (Custom available)</p>
		
<p>IE-A04</p> <p>All in one corrugated tube cut machine With feeder for long corrugated tube Dia: 4-25mm (Custom available)</p>	<p>IE-M05</p> <p>Powerful corrugated tube cut machine For thin metal tube or thick plastic tube Dia: 4-25mm (Custom available)</p>	<p>IE-P06/V07</p> <p>Visual orientation tube cut machine Precision cut bellows wave valley or peak Dia: 4-25mm (Custom available)</p>
		

Cutting materials samples:



3Q Twist Tie Machine Full Automatic Power Plug Cable Wire Coil Winding Binding Machine

Specification

- Name - Automatic wire winding and binding
- Usage - Stripping
- Usage - wire winding and binding
- Application - wire winding and binding
- Type - wire winding and
- Wire Range - 0-2.5mm
- Electric Wire Stripping Machine - Multi function Wire Stripping
- Function - wire winding and binding
- Production weight - 30kg/35kg/45kg
- Applicable wire - AC/DC/USB cable
- Winding appearance - Small figure 8 single cable tie
- Applicable cable length - ≤ 3 m (depending on the type of wire)
- Applicable wire diameter - $\leq \phi 4$ mm
- Voltage requirements - 210-240V 5A
- Winding pitch - 45-80mm
- Machine power - ≤ 2000 W
- Diameter - ≤ 20 mm

- Keep the length of the head- 0-130 mm
- Keep the length of the tail- > 0 mm
- Productivity - 1800pcs/h(Take 3 turns with a wire length of 1 meter, showing the head and tail)
- Air pressure requirements - 0.55-0.65Mpa
- Applicable cable tie - Rubberized iron core
- Gas consumption - Air consumption of ordinary peeling machine
- Tie weight - < 7 kg
- Machine size - About 1040L *720W* 1540H mm
- Lap speed - Can be adjusted
- Machine weight - About 160KG



Electric data cables bundle and tie machine wire winding machine automatic wire tie bundle machine

- Specification
- Product name - Automatic Winding machine
- Power supply - AC220V /50Hz 80W
- Tie length - 65-100mm
- Applicable diameter OD - 5-25
- Tie length - 75-120mm
- Applicable diameter OD - 15-30
- Tie length - 75-120mm
- Applicable diameter OD - 25-45
- Number of coils - Can be set by yourself 3-5 circles recommended
- Tie - Rubber core
- Protective device - Fuse, fault alarm and shutdown
- Dimension -400*280*400mm
- Weight - 12KG



Automatic Wire winding machine

This machine is suitable for AC power cords, DC power cords, USB data cables, sheathed cables, shielded cables, video cables, HDMI high definition cables and other transmission lines that are twisted into bundles with rubber cores.



Automatic wire straightening and twisting machine with brushing function manually

Products Description

- Function:- Wire brushing, wire splitting & twisting machine
- Voltage:-220V 50-60Hz
- Air Pressure:-4-6kg/cm²
- Power :- 10W
- Line speed:- Stepless speed change
- Cattle line Direction:-positive & negative adjustable
- Weight:- 8kg
- Appearance dimension:- 300*200*180mm

This machine can brush and tighten all kinds of ground wires, braided wires and isolation wires, completely replacing manual operation and improving work efficiency

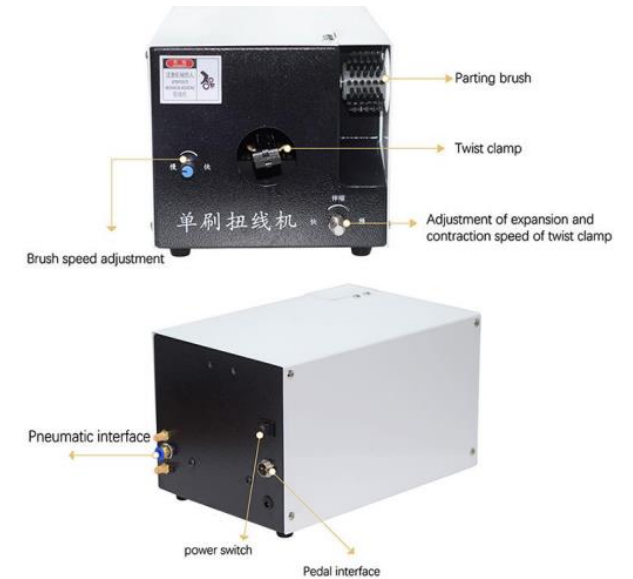
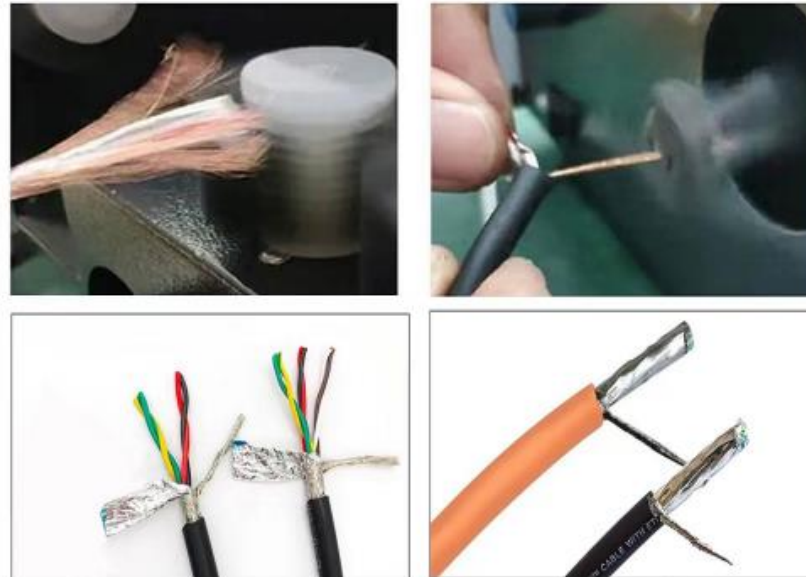

Semi-auto 3 brushes for braided wire splitting brushing shield braid layer brushing twisting winding machine

Products Description

- Function - Braided metal shielding, two-way rotation, adjustable brush spacing, safety cover
- Brushing speed - 0 - 6000 RPM
- Brushing length - 5 - 80 mm
- Cable diameter - 0.1 - 25 mm
- Rated power - 100 W
- Power supply - AC 220 V \pm 10%, 50 / 60 Hz [110V on request]
- Dimensions - L 320 x W 220 x H 260 mm
- Weight - 12 KG

Specification

1. Use for the braiding and twisting cable shields
2. Brushing length up to 35 mm max
3. Twisting length up to 80 mm max
4. Adjustable brush spacing for max 25 mm diameter cable
5. Brush speed adjustment for shield de-interlacing
6. Quickly changeable brushes
7. Lightweight, space-saving design

Cable Shield Braid Brushing and Twisting Machine

(Wire diameter:Max. 8 mm)



Before brushing



After brushing



After twisting



Wire brushing machine high quality braided wire winding twisting machine

Model	WJ-20 Automatic brushing and twisting machine
Air pressure	1.5-2.5kg/CM
Power	AC 220V 50Hz 10W
Twisting speed	1400circle/s
Twisting length	5-80mm (150mm customizable)
Wire range	0.1-2(mm)
Dimension	L340×W190×H170mm
Weight	12KG
Brushing motor	12v 3000circle/s
Brushing wire range	0.1-10mm
Brushing stripped length	1-60mm(can be brushed up to 80-100mm depending on material of wire)

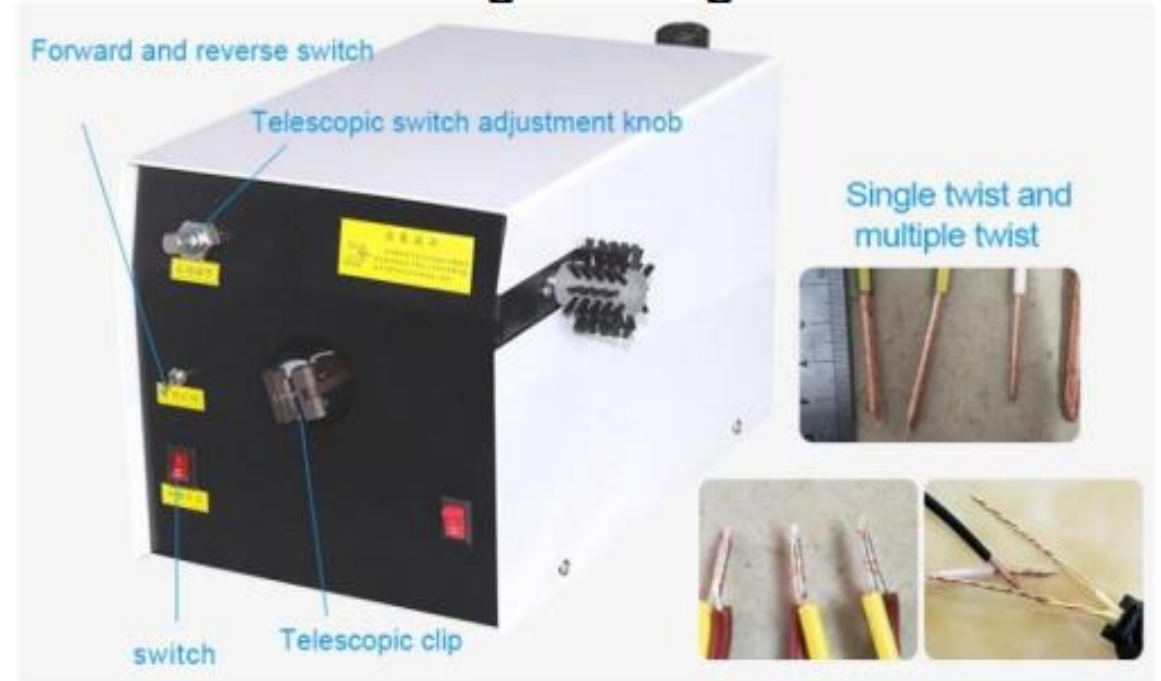

Shielded wire brush machine

Model	EW-1010
Wire diameter	1-8mm
Brushing length	5-50mm
Motor speed	1-6000rpm (Can be adjusted)
Power	50W*2
Weight	10kgs
Dimension	320*220*260mm

Feature

Various shielded wires and shielding nets (including winding and braiding) can be brushed smoothly. Later processing, the direction and speed are adjustable, the performance is stable, the brush wire can be adjusted for different sizes of wire.



Before Brushing

After Brushing



Braid Wire Cable Brushing Machine With Crawler Semi-Automatic Shielding Cable Brushing Machine

• Specification

1. Shielding wire cables combing machine
2. New energy harness shielding net card combing
3. Wire shield splitting combing machine

Model	SR-30
Voltage	AC 220V 50/60Hz
Motor Power	400W*2
Brush Distance	Adjustable
Wire Brushing Length	5-200mm
Applicable Wire Diameter	1-30mm
Applicable Cable	Shielded wire, braided wire
Speed	0-1800rpm(can adjust)
Size	400*480*320mm
Weight	52kg



Cable twisted wire straighten tool Multi core wire straightening machine

Products Description

- Model – BORX-37B
- Product name - Wire straightening machine
- Power supply - AC 220V / DC24V 3A
- Transfer method - Pneumatic
- Volume - 202*104*230 mm
- Weight - 7KG
- Maximum thread length - 10-60 mm
- Control way - Foot switch control

Wire straightening machine

The network cable twisting machine is mainly used for multi-core cable straightening, it can be applied to HDMI, multi core industrial control cable, multi core type C, USB 3.0 cable stranding and straightening, network cable rub and straightening etc.



PRODUCT PARAMETER



- MODEL NO.- IE- 37B
- Product Name – Wire Straightening Machine
- Transfer Method - Pneumatic
- Related Voltage – Adapter AC-220V /DC-24V 3A
- Volume – 202*104*230mm
- Weight – 7kg
- Maximum Thread Length – 10-60mm
- Way to Control – Foot Switch Control

Model No. IE – 809D

Product Name	Wire Straightening
Input Power	AC100-220v 50-60Hz
Motor Power	30-60W
Compressed Air	0.2-0.5MPa
Thread Length	10-60mm
Operational Control	Foot Switch
Shell Material	304 Stainless Steel
Weight	(.5kg
Host Size	29*24*21cm
Fragile & Consumable Parts	Washboard, Foot Switch
Remark	Special specification product can be customized please send samples to us for reference when ordering



PACKING & SHIPPING

GOLD SUPPLIER
QUALITY FIRST

SCIENTIFIC MANAGEMENT

To ensure the safety of the goods delivered to your hands.



Land Transportation



Shipping

Air Freight



 **Indoe Enterprises**
Industrial Goods And Machinery Supplier

 sales@indoenterprises.com

 8299544092

 G-232 Sector-63 Noida-201301